

® ***HYPERPRO***  
***Suspension Technology***

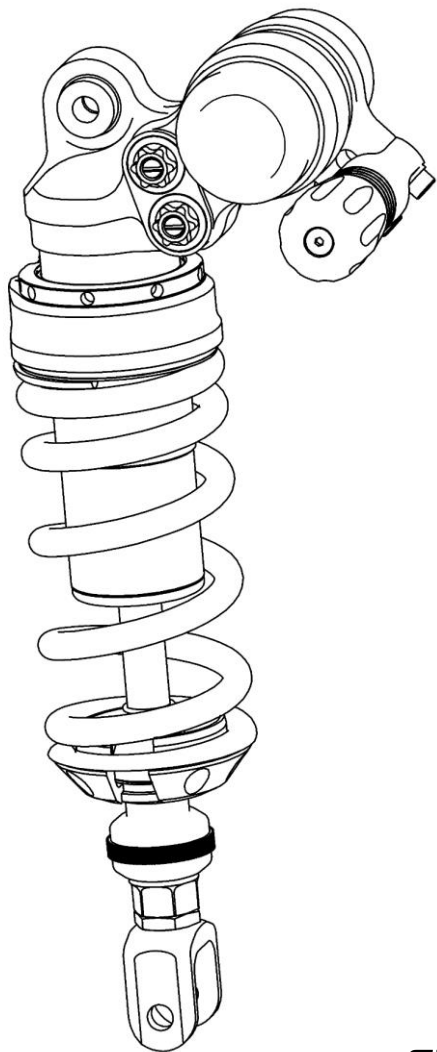

***Shock manual***

V3.1 ENGLISH



## INDEX

	<i>Page</i>
<b><i>Hyperpro Shock Overview</i></b>	4
Maintenance	5
<b><i>Rear Shock unit, removal and installation</i></b>	
M1    Mono shock (& Telelever front)	6
M2    Twin shock	6
M3    Link system	6
M4    Remote reservoir / Remote preload adjuster	7
<b><i>Setup</i></b>	
S1    Things to check first	8
S2    Static Sag measurement and adjustment	9
S3    Damping setup	11
S4    Handling troubleshooting chart	15
<b><i>Setting Label</i></b>	16

**Safety remarks** – important safety information is highlighted by the following notations:

- **WARNING!** – Failure to follow warning could result in severe or fatal injury.
- **NOTE:** - Indicates information that is of importance with regard to procedure.

**WARNING!** – Please study this owner's manual and make sure that you fully understand the mounting instructions. If you have any questions regarding proper installation, contact a Hyperpro dealer.

**HYPERPRO SHOCK OVERVIEW**

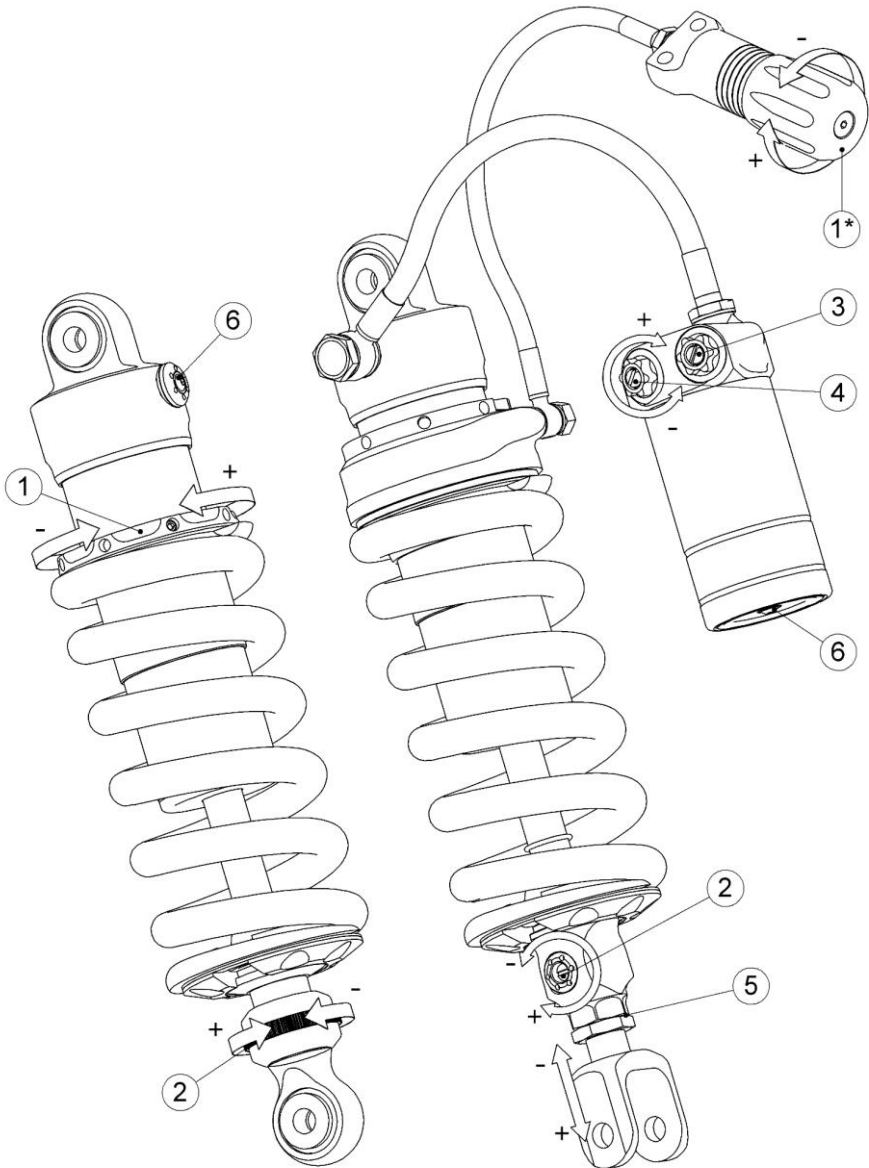

Hyperpro basic emulsion shock (left) and full option shock with reservoir

**1 Spring Preload adjuster** – adjusts the amount of spring preload, which determines the amount of sag (see S2). Requires a special tool, included with the shock absorber. To adjust the preload, first find and loosen the lock bolt (7) in one of the holes of the adjuster ring. Use the special tool in the holes to adjust the spring preload. Make sure that the lock bolt (7) is tightened after every adjustment.

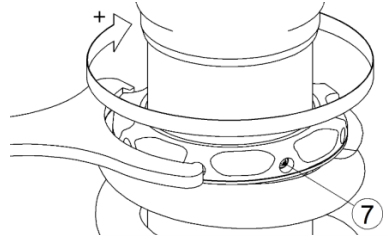

**1\* Hydraulic Preload adjuster (optional)** – allows easier spring preload adjustment without tools. Simply turn clockwise to increase spring preload.

**2 Rebound damping adjuster** – adjusts the amount of damping when the shock is extended. Available as manual twist adjuster (+/- 48 clicks) or screwdriver adjuster (+/- 28 clicks).

**3 Compression High speed adjuster** (purple color or marked “H”) – adjusts the amount of damping when the shock is compressed in the high speed range (+/- 28 clicks).

**4 Compression Low speed adjuster** (gold color or marked “L”) – adjusts the amount of damping when the shock is compressed in the low speed range (+/- 28 clicks).

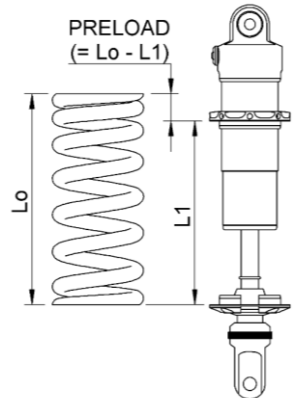

**5 Length adjuster (optional)** – adjusts the length of the shock to change the rear ride height, without sacrificing sag. Use a 22mm wrench to loosen the lock nut, then adjust the length by rotating the shock (22mm wrench) or the mount eye/ fork. **WARNING!** – make sure the mark is just visible, not further! At least 8mm of thread should be in the shock. Make sure that the lock nut is tightened after every adjustment!

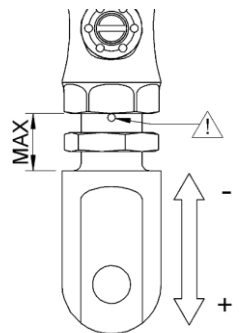

**6 Nitrogen filling plug** – Shock absorbers contain pressurized gas, **DO NOT OPEN!**

## SHOCK MAINTENANCE

In general, inspect the shock regularly for damage and leakage. Wash the shock with a mild detergent. Be careful with compressed air/ power cleaners and avoid using aggressive cleaning agents. Protect your shock with WD40 or similar.

Hyperpro shocks are to be serviced every 20.000km or once every 2 years (whichever comes first) by a certified Hyperpro Service dealer.

## REAR SHOCK MOUNTING INSTRUCTIONS

**NOTE:** We strongly advise to follow your vehicle's workshop manual for the correct mounting procedure.

- 1 Place the bike firm and stable with the rear wheel free from the ground. Do not use a bike stand that supports the swing arm.
- 2 Remove cases, seats and bodywork if necessary to reach the mounting points of the shock absorber.
- 3 If the shock has a remote reservoir and/ or hydraulic preload with a remote adjuster, they have to be removed from the bike along with the shock. Remove the bolt(s) or clamp(s) of the remote parts, so they are loose and can be removed.

**WARNING!** - The hoses must not be detached from the shock, system can be pressurized!

### M1. MONO SHOCK (& TELELEVER FRONT)

- 4 Remove the nuts from the shock absorber mounting bolts (1 & 2).
- 5 Support or lift the rear wheel to take out the shock bolts and remove the shock from the bike.
- 6 Place the Hyperpro shock in the motorcycle. Place the top bolt (1). Lift the rear wheel up to place the bottom bolt (2). Tighten the nuts to the correct torque settings. If present, mount the remote reservoir and/ or remote preload adjuster to the bike.

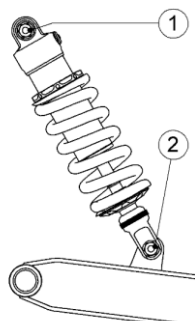

### M2. TWIN SHOCK

- 4 Remove the nuts from the shock absorber mounts (1 & 2).
- 5 Support or lift the rear wheel to take out the shock bolt(s) and remove the shocks from the bike.
- 6 Place the Hyperpro shocks in the motorcycle. Place the top bolt or nut (1). Lift the rear wheel up to place the bottom bolt (2). Tighten the bolts and/ or nuts.

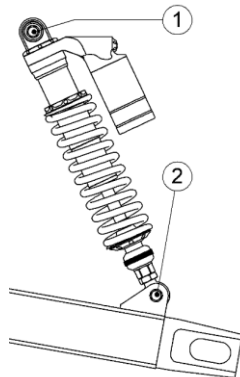

M2 - twin shock

### M3. LINK SYSTEM

The link system can be found underneath the swing arm. Sometimes it is necessary to remove parts of the exhaust or bodywork for better access.

**NOTE:** make sure all link system parts can be mounted in the correct position and direction. Check for markings (e.g.: arrows) or make your own, take pictures and check your vehicle's service manual. Incorrect assembly influences the handling and may lead to dangerous situations!

Check the condition of the rear suspension parts. Clean and re-grease where necessary. Check all bearings and seals for damage and excessive play, replace them if necessary.

### M3.1 LINK SYSTEM – STRAIGHT LINK PLATES

- 4 Remove nuts (3) and (4). Support or lift the rear wheel to remove the bolts and link plates (5).
- 5 Remove the nuts from the shock absorber mounting bolts (1 & 2). Remove the shock bolts and remove the shock absorber from the bike. If there is not enough space to remove the shock absorber, also remove bolt (6) and the link (7).
- 6 Place the Hyperpro shock in the motorcycle. Place the top bolt (1). Mount all the parts in the correct order and lift the rear wheel up to place the final bolt (3 or 4). Tighten the nuts to the correct torque settings. If present, mount the remote reservoir and/ or remote preload adjuster .

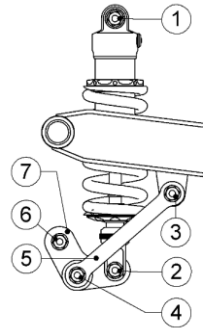

M3.1 - straight plates

### M3.2 LINK SYSTEM – TRIANGULAR LINK PLATES

- 4 The easiest way is to remove the link plates. Make sure all parts can be refitted in the correct position. Usually it is enough to remove the shock bolt (2) and one of the link bolts (3 or 4) to remove the shock absorber. Remove more parts if more space is needed.
- 5 Remove the top nut and bolt (1) and take the shock absorber out of the bike. Depending on the bike this is possible along the upper side of the swing arm or underneath. Sometimes it is necessary to lift the rear wheel to create enough space to take the shock out.
- 6 Place the Hyperpro shock in the motorcycle. Place the top bolt (1). Mount all the parts in the correct order and lift the rear wheel up to place the final linkage bolt. Tighten the nuts to the correct torque settings. If present, mount the remote reservoir and/ or remote preload adjuster.

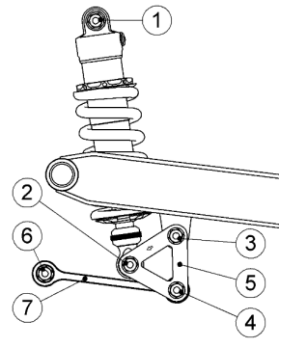

M3.2 - triangular plates

### M4. REMOTE RESERVOIR & REMOTE PRELOAD ADJUSTER

If the Hyperpro shock absorber is equipped with a remote reservoir and/ or a remote preload adjuster, then the remote parts need to be mounted on the motorcycle with the included parts.

**NOTE:** Please read the additional mounting instruction manual for more specific information.

## S1. SETUP, things to check first

Before there are any adjustments made to the suspension settings, be sure everything else is in a good working order using the following steps. Look up the details and settings in your motorcycle manual. Handling problems do not only occur when the suspension is set up wrong. Setting up the suspension is useless when the rest of the bike is bad!

- **Check the tires** - Wrong tire pressure can cause various handling problems, it should be checked regularly to insure good handling. The tire manufacturer can provide the correct information for your tires. Check the tires for any unusual wear, damage, leaks and correct thread depth. If the tires are worn out or otherwise bad, replace them.
- **Check the front suspension** - Place the bike stable with the front wheel off the ground. Make sure there is no weight resting on the front suspension. Grab the forks near the front axle. Try to push them front and back, there should be virtually no play between the steering head and the forks. Also notice if there is play in the forks, there should be very little play between the inner and outer tube. If there is play, it is likely the fork bushings are worn out; the fork should be rebuilt.  
The steering stem can be tightened to set the play. Too tight and the steering becomes heavy. If there is play with a tight steering stem, check the steering head bearings as they are probably worn out, replace them if necessary. Steer the bike. If the movement is not smooth and/or notches are felt, the steering head bearings should be checked and if worn out they should be replaced.  
Check the front suspension for leaking seals, replace them if necessary.
- **Check the rear suspension** - Place the bike stable with the rear wheel off the ground. Do not use a stand which supports the swing arm.  
Try to move the swing arm from side to side. There should be little play between the swing arm and the rest of the bike. If there is play the swing arm bearings should be checked and if worn out they should be replaced.  
Try to move the swing arm up and down. Feel for play between the swing arm, the frame and the shock bearings. If there is play, the bearings of the swing arm, link system and/ or the shock absorber are probably worn out.
- **Check the chain** - Make sure the chain slack is set correctly. Clean and lubricate the chain if necessary. The lubricant penetrates best when the chain is warm, just after riding the bike.  
Tip: lubricate the chain after driving in the rain as the lubricant can be washed off by the rain. Make sure the wheel and sprockets are aligned properly. There are usually measurement stripes on the swing arm, for the alignment of the rear wheel when the chain free play is adjusted.  
If any chain links are damaged, worn out, do not move smooth and/ or the sprockets are worn out, the chain and sprockets should be replaced.
- **Check the wheels** - Make the wheels spin. If a wheel doesn't move smooth or has a lot of drag, check if the brake is dragging. If a wheel has play in the mounting (the wheel can move sideways while the axle is tightened) the bearings are probably worn out; replace them if necessary. If there still are a lot of vibrations during riding, check the balancing of the wheels.
- **Check the wheel alignment** - if the wheels are not aligned properly the bike tends to steer to one side. This is also the case when the frame is not straight; if your bike has been in a crash it is possibly bent.

**NOTE:** If your bike is technically not in a good working order, visit a qualified dealer for service.



## S2. STATIC SAG, measurement and adjustment

*Static sag is the amount of stroke that is used as a result of the bike's own weight, without rider. It is best measured by two people; one measuring while the other is holding the bike upright.*

### S2.1 FRONT STATIC SAG MEASUREMENTS

Choose a distance to measure between the triple clamp and the wheel axle (e.g. visible chrome length). Measure the following situations:

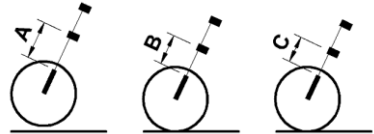

S2.1 - sag measurements front

- A** Reference - Front wheel off the ground, no weight rests on the front suspension.
- B** Sag high - The bike is on both wheels, on a flat surface without rider. Pull up the front of the bike and let it come down on its own weight very slowly, don't push!
- C** Sag low - The bike stands up on both wheels, on a flat surface without rider. Push the front of the bike down and let it come up very slowly, slow down the movement so it does not bounce.

$$\text{Calculate Front Static Sag} = A - \left( \frac{B + C}{2} \right) = \dots \text{ mm}$$

Find the correct **STATIC SAG** on the Hyperpro fork spring manual or in the motorcycle's service manual. Front sag can be modified by changing the amount of fork spring preload, see S2.3. (For road use, the front sag without rider should be about 20% of the maximum fork stroke.)

### S2.2 REAR STATIC SAG MEASUREMENTS

measure the length of the swing arm (L) Use a piece of tape to mark a point at the same distance (L) from the swing arm front bolt to the fairing. **NOTE:** Be sure to use tape that does not damage the fairing. Measure the distance from the rear axle to the point when:

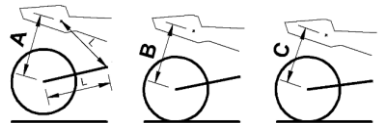

S2.2 - sag measurements rear

- A** Reference - The rear wheel is off the ground, no weight rests on the rear suspension.
- B** Sag high - The bike is on both wheels, on a flat surface without rider. Lift the rear end of the bike and let it come down under its own weight slowly, don't push!
- C** Sag low - The bike stands on both wheels, on a flat surface without rider. Push the rear of the bike down let it come up slowly, don't let it bounce!

$$\text{Calculate Rear Static Sag} = A - \left( \frac{B + C}{2} \right) = \dots \text{ mm}$$

Find the correct **STATIC SAG** on the label.

Rear sag can be modified by changing the amount of rear spring preload, see S2.3.

(For road use, the rear sag without rider should be about 10% of the maximum rear wheel travel.)

**NOTE:** Sometimes preload and static sag are both mentioned on a label or in a service manual. The static sag is the most important value, if necessary adjust the preload until the desired sag value is reached.

## S2.3 SAG ADJUSTMENT

Sag can be adjusted with the spring preload adjuster (if available). Adjust the preload in the correct direction and measure B and C again until the correct static sag is reached.

*For less sag, apply more spring preload.  
For more sag, apply less spring preload.*

**Front:** Preload adjustment is easy if your fork is equipped with preload adjusters (1), usually less rings visible indicates more preload. (check the your vehicle's owner's manual for the exact location and function).  
Make sure both fork legs have the same preload setting.

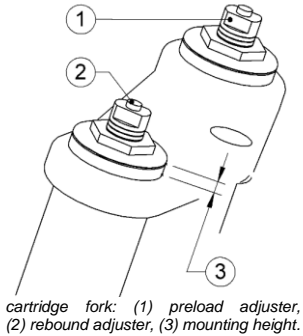

**Rear:** Use the special tool in the holes to adjust the spring preload. Make sure that the lock bolt (7) is loosened before, and tightened after every adjustment.

Hydraulic adjuster: simply turn knob (1\*) clockwise to increase spring preload.

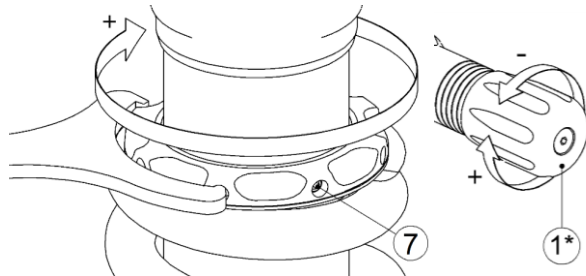

## S2.4 SAG COMPENSATION FOR DUO OR EXTRA LOAD

Under heavy loads (i.e. with a passenger and luggage for a vacation) the sag increases. The bike is closer to the ground, there is less ground clearance. It is possible to apply more preload to compensate this.

Duo riding and/or luggage affect the shock more than the fork, as most weight is carried at the rear of the bike, so the preload increase for the shock should usually be larger.

Measure the rear static sag (see S2.2), without rider, but with the additional weight (passenger and/or luggage) on the bike. Increase the spring preload until the static sag is the same as the recommended **STATIC SAG** on the label.

Make sure you write down the preload adjustment (turns), so you can easily adjust back to the normal setting when necessary.

### S3. DAMPING SETUP

*The damping only adjusts the speed of the suspension movement, not the spring force.*

The suspension will eventually move the same distance when the applied force is the same for long enough, independent of the damping. Damping settings only change the time it takes to get there. More damping slows the movement down and less damping makes it faster.

- **Rebound damping** controls the speed with which the suspension extends to the normal ride height after going over a bump or when releasing the brake. Rebound damping is also sometimes referred to as tension damping (“TEN”).
- **Compression damping** controls the speed with which the suspension is pushed together when hitting a bump or braking hard. Compression damping is also sometimes referred to as bump damping.

Rebound and compression damping settings can affect each other slightly in some forks and shocks. For example: a big increase in fork rebound damping can also give an increase in fork compression damping.

Left and right forks and shocks cannot affect each other obviously as the damping oil is separated, they should be setup equally. Some forks use separate function internals and will have only compression damping in one leg and only rebound damping in the other, check your vehicle’s owner’s manual for the available adjusters and their location on your bike.

First check the overall condition of the bike and make sure the static sag is adjusted properly before setting up the damping (see chapters S1 and S2).

To set the suspension up properly, test ride the bike every time something is changed.

If you change the suspension settings, the bike feels and handles different. Test ride the bike according to your normal riding conditions and riding style. Always ride safely and don’t take unnecessary risks! Avoid riding in heavy traffic because it can be dangerous when the bike handles different.

#### S3.1 BASIC DAMPING SETUP

- **Check the current setting and write it down.** Turn the damping screws to the maximum (clockwise) counting the number of clicks or turns while doing so. Clicks or turns are always counted from the maximum setting outwards (counter clockwise).
- **Use the base settings recommended by HYPERPRO.** They can be found on the labels (view: **REBOUND & COMPRESSION**). The HYPERPRO recommended settings are average settings for normal use. It is possible to adjust the suspension to your personal preference and driving style.
- Push the front and rear suspension and if it feels ok, **go for a test ride.**  
If you are happy with the setup, you have finished the installation!  
If you are not happy with the setup, you may proceed to the following chapters to find a better setting or, if you are not comfortable doing this yourself, consult a Hyperpro Service Dealer.

## **S3.2 ADVANCED DAMPING SETUP - FRONT**

- **First, fully open the compression damping** (turn CCW until minimum is reached). This will allow you to push the fork without any restriction.
- **Increase the rebound damping until the suspension comes up with a smooth movement.** It should not move too fast (shoot up) and only bounce once; after pushing it should come up, top out, move back down to the static sag height and stop.
- **Increase the compression damping until it feels controlled, without being restrictive.** Use as little compression damping as possible. The major part of the suspension force should be absorbed by the spring, with the damping as a speed restriction. If the suspension compresses too fast increase the compression damping. Reduce the compression damping when the suspension compresses too slow, the bike feels harsh and bumps are directly passed through the frame to the rider.

**Too much rebound damping** makes the front feel locked up and harsh, feel of control is lost. Too much rebound damping can make the fork pack down; the bike does not return fast enough to the standard ride height after being compressed and gets lower and lower over a series of bumps. The front sits low and the bike tends to oversteer (drives towards the inside) in long fast corners and it sits up in slow corners. While accelerating, the front can tank slap because the front wheel loses traction.

**Too little rebound damping** makes the fork jump up when the brake is released. The suspension extends too fast when entering a corner, causing understeer in fast corners and falling down to the inside in slow corners. The front feels vague and gives little feedback.

**Too much compression damping** can make the fork compress too slow, resulting in slow steering into fast corners. Much compression damping can feel good during hard braking although the front feels very harsh over bumps, sometimes even kicking up. The front can shake and most bumps are felt directly through the handlebars.

**Too little compression damping** can make the fork dive much too fast during braking. The bike does not feel controlled when braking hard and over bumps. The bike oversteers (steers too fast) into corners. Under hard braking the rear wheel can lose traction.

### S3.3 ADVANCED DAMPING SETUP - REAR

- **First, fully open the compression damping** (turn CCW until minimum is reached). This will allow you to push the rear without any restriction.
- **Increase the rebound damping until the suspension comes up with a smooth movement.** It should move as fast upwards as possible, without overshooting the static sag level. Push the rear, as the bike comes back up it should move with your hands, you shouldn't be able to lift your hands from the bike and the bike shouldn't be able to push your hands upwards.
- **Increase the compression damping until it feels controlled, without being restrictive.** Use as little compression damping as possible. The major part of the suspension force should be absorbed by the spring, with the damping as a speed restriction. If the suspension compresses too fast increase the compression damping. Reduce the compression damping when the suspension compresses too slow, the bike feels harsh and bumps are directly passed through the frame to the rider.

**Too much rebound damping** can make the rear pack down; the bike sits low at the rear and runs wide going out of long corners. The rear feels locked up and harsh. The bike sometimes kicks over bumps. The rear tire has bad traction, because the suspension doesn't allow the rear wheel to follow the road surface properly. The rear wheel bounces or hops uncomfortably over the ground during hard braking.

**Too little rebound damping** can make the bike wallow in a corner and over bumps. The rear can feel less controlled; it acts like a pogo stick. During hard braking the rear wheel has little traction and feels like it slides over the ground; it feels like the bike wants to pivot around the front. It's difficult to hold the bike in a straight line during braking.

**Too much compression damping** can make the rear feel very hard. The rear of the bike can kick up over bumps and most bumps are felt directly through the chassis. With too much compression damping the rear wheel can lose traction and slide while accelerating hard; the rear tire will overheat.

**Too little compression damping** can make the rear compress too fast when accelerating. The bike squats, causing understeer, the bike runs wide when accelerating hard out of fast corners. Sometimes the rear compresses so fast it results in tank slapping due to loss of traction at the front tire.

Sometimes there are separate **high speed and low speed damping** adjusters. High speed and low speed refer to the speed of suspension movement, not the road velocity of the motorcycle.

- **High speed damping** controls high speed suspension movements; i.e. hitting a big bump in the road. On a bump the suspension has to move very fast to absorb it. Don't use a lot of damping as this causes harshness, the wheel must be able to follow the road surface in order to maintain traction.
- **Low speed damping** controls low speed suspension movements; i.e. front compression during braking or rear compression during accelerating. Normally there is more low speed damping necessary than high speed damping. Low speed adjustments usually also affect the high speed adjustment; if the low speed damping is increased, the high speed damping is also increased.

The shape of the bump and the speed with which the bump is taken are the biggest influence for the speed with which the suspension must compress in order to make the tire follow the road surface. A sharp edged bump creates a higher suspension compressing speed than a rounded bump of the same height.

*If the bike is harsh over bumps: decrease the high speed compression damping. If the bike dives too fast under braking: increase front low speed compression. If the rear squats too fast under acceleration: increase rear low speed compression.*

Separate high and low speed damping adjusters are usually found on the compression only. Rebound can do with a single adjuster for the whole speed range, because the bike rebounds under the force of the spring; this is more consistent and independent of road conditions.

### **S3.4 ADVANCED DAMPING SETUP – FRONT AND REAR BALANCE**

There must also be a balance between front and rear. Hold the bike when it is on both wheels. Push in the centre of the bike (seat or tank) and notice how it sags and comes back up.

Front and rear should compress and rebound at roughly the same rate. The suspension travel should be about the same distance front and rear.

The suspension can move a bit faster at the front, although the difference must not be too big as that would result in wallowing (weave/ wobble) and unstable handling behaviour through corners.

### **S3.5 DAMPING COMPENSATION FOR DUO OR RACING**

For racing or duo riding there usually is some more damping needed than under normal conditions, in order to absorb the higher forces. Turn the adjustment screws a few clicks clockwise to increase the damping.

Duo riding and/or holiday luggage affect the shock more than the fork, as most weight is carried at the rear of the bike, so the damping increase for the shock should usually be larger. Racing affects the front as much as the rear.

Find an optimum setting that suits your riding style. Experiment by increasing or decreasing the damping to give the bike the desired handling behaviour. Use your own notes and experience to get a good feeling for the handling of your bike.

#### S4. HANDLING TROUBLESHOOTING CHART

First check the overall condition of the bike and make sure the static sag is set properly (S1 & S2).

Suspension parameter ► Handling problem ▼	Front preload	Front rebound	Front compression	Rear preload	Rear rebound	Rear compression	Ride height / geometry	Notes
<i>Long fast corners: Bike runs wide (understeered) Bike sits up</i>	-	+	-	+	-	+	lower front / raise rear	Front end rides high through the corner (multiple possible causes)
<i>Long fast corners: Bike runs narrow (oversteered) Bike falls in</i>	+	-	+	-	+	-	raise front / lower rear	Front end rides low through the corner (multiple possible causes)
<i>Short slow corners: Bike falls down to the inside (oversteered)</i>	-	+	-	+	-	+	lower front / raise rear	Front end rides high through the corner (multiple possible causes)
<i>Short slow corners: Bike sits up while turning (understeered)</i>	+	-	+	-	+	-	raise front / lower rear	Front end rides low through the corner (multiple possible causes)
<i>Front dives too fast when braking hard, doesn't bottom out</i>			+					Bike usually also oversteers in fast corners, steers into corners too easily (falls in)
<i>Front shoots up too fast after braking, turning into corners is difficult</i>		+						Bike usually also understeers in fast corners
<i>Rear squats fast under acceleration</i>				2nd +		1st +		Bike usually understeers when accelerating out of long corners
<i>Rear wheel loses road contact (traction) under hard braking</i>	3rd +		2nd +	4th -	1st +			It feels like the rear pivots around the front wheel, also a lot of dive during braking
<i>Tank slapping / front end shake at high speeds and fast acceleration (wobble)</i>		2nd -			3rd +	1st +	4th lower front / raise rear	Loss of front tire traction. A steering damper can reduce the unstable feel
<i>Wallowing / weave in mid corner (long, fast corners)</i>		2nd +	4th +		1st +	3rd +		A steering damper can reduce the unstable feel
<i>Over a series of bumps or ripples the bike packs down, there is no more travel to absorb bumps</i>		-			-			There is too much damping for the suspension to return fast enough to the normal ride height, ride is harsh
<i>Bike feels too harsh over bumps, suspension feels "locked up" over bumps, the bumps are felt directly through the frame</i>			-			-		Harshness is felt when the bike kicks up or skips over bumps. Locked up and harsh feel can also be caused by packing down!

+ increase, more / - decrease, less

The numbers reflect the likeliness of the solution (1st is most likely).

Ride height is adjusted with fork mounting height, shock length adjuster or link plate dimensions, but NOT with the spring preload.

This table only indicates the most common problems with the most likely solutions. Many handling problems are more complicated; please contact Hyperpro if your problem cannot be solved with this manual.

**SETTING LABEL**

**WARNING!** – Installing a suspension component that is not correct for your bike can affect the stability of your bike. Hyperpro cannot be held responsible for any form of damage to any component, motorcycle or personal injury when there is improper installation of the component and/or if the instructions for mounting or maintenance are not followed exactly. Similarly, the warranty will become void if the instructions are not followed.

This document may be available for download in other languages, please see our website:

***WWW.HYPERPRO.COM***

Hyperpro Suspension Technology, Hulsboschstraat 26, 4251LR, Werkendam, The Netherlands

+31(0)183-678867, info@hyperpro.com